

ECO Series Shock Absorbers



ITT

ENGINEERED FOR LIFE



RoHS
COMPLIANT

Enidine **New ECO Series** non-adjustable hydraulic shock absorbers can accommodate varying energy conditions. This family of tamperproof shock absorbers provides consistent performance, cycle after cycle. Non-adjustable models are designed to absorb maximum energy within a compact envelope size.

The **ECO Series** was designed using materials and fluids that are safe for our environment. Models can accommodate a wide range of operating conditions with varying masses or propelling forces. The **ECO Series** offers a flexible design to accommodate a wide variety of application parameters. Whether your application has a low velocity/high drive force or high velocity/low drive force condition, the **New ECO Series** will deliver the performance that you have come to expect.

Features and Benefits

- **Extensive non-adjustable product line** offers flexibility in both size and energy absorption capacity to fulfill a wide range of application requirements.
- **Environmentally friendly materials:**
 - ROHS Compliant materials
 - Bio-degradable hydraulic oil
 - Copper-Free design
 - Recyclable packaging materials
- **Introducing our new Enicote II surface finish:**
 - ROHS Compliant
 - Rated at 350 hours salt spray corrosion protection
- **Jam Nut included** with every shock absorber.
- **ISO quality standards** result in reliable, long-life operation.
- **Tamperproof design** ensures repeatable performance.
- **Threaded cylinders provide mounting flexibility** and increase surface area for improved heat dissipation.
- **Wrench flats** promote ease of mounting
- **Capability to mount into pressure chambers**
- **Integrated positive stopping capabilities** up to 100 psi (7 bar).
- **Special materials and finishes** can be designed to meet specific customer requirements
 - Optional fluids and seal packages can expand the standard operating temperature range from (15°F to 180°F) to (-30°F to 210°F)
 - Food grade options available

Enidine Non-Adjustable Multiple Orifice Shock Absorbers

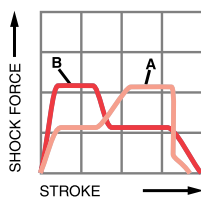
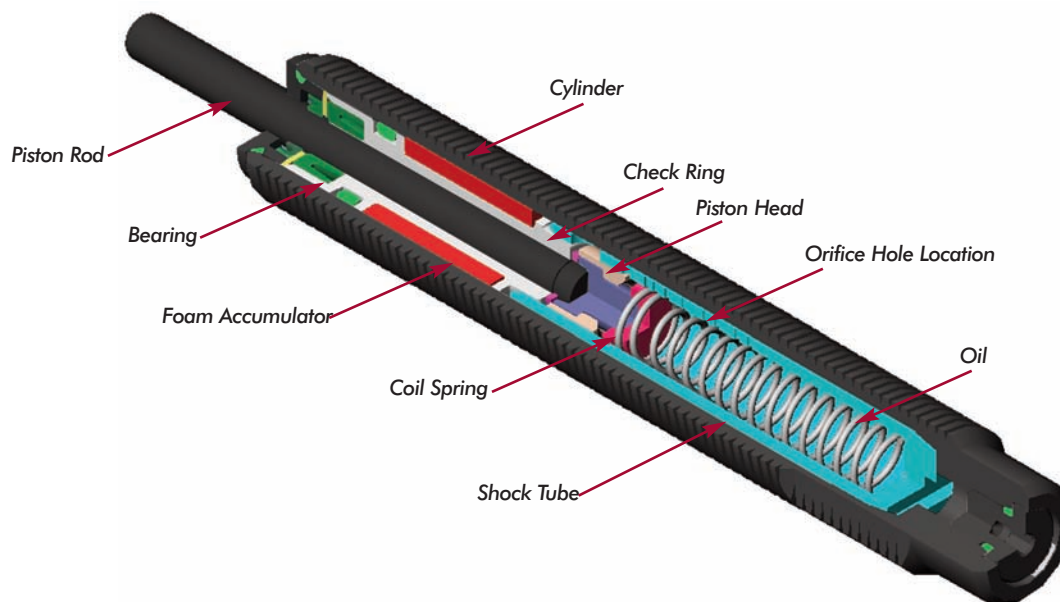

Self-compensating damping maintains acceptable deceleration with conventional type damping characteristics. Self-compensating shock absorbers operate over a wide range of weights and velocities. These shock absorbers are well suited for high drive force, low velocity applications, and where energy conditions may change. Curve A shows the *shock force vs. stroke* curve of a self-compensating shock absorber impacted with a low velocity and high drive force. Curve B shows the *shock force vs. stroke* curve of a self-compensating shock absorber impacted with a high velocity and low drive force.

The design of a multi-orifice shock absorber features a double cylinder arrangement with space between the concentric shock tube and cylinder, and a series of orifice holes drilled down the length of the shock tube wall.

During piston movement, the check ring is seated and oil is forced through the orifices in the shock tube wall, into the closed cellular foam accumulator and behind the piston head.

As the piston head moves it closes off orifice holes, thus reducing the available orifice area in proportion to the velocity. After the load is removed the coil spring pushes the piston rod outward. This unseats the check ring and permits the oil to flow from the accumulator and across the piston head, back into the shock tube. This allows quick repositioning for the next impact.

Low Pressure multiple orifice shock absorbers can provide progressive or self-compensating damping, depending on the impact conditions.

Standard

ECO 8 → ECO 10 Series

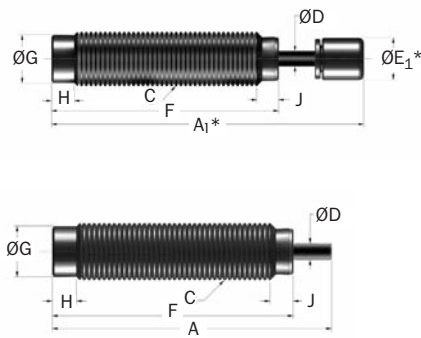

ECO 15 → ECO 100 Series

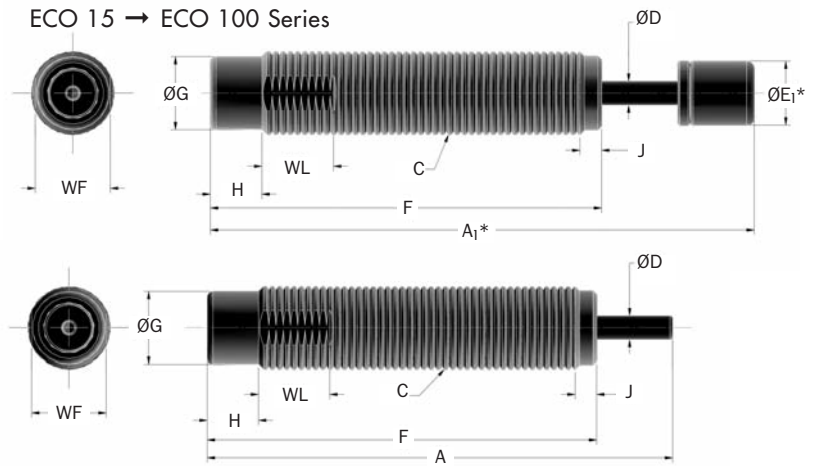

*Note: A₁ and E₁ apply to button models and urethane striker cap accessory.

Catalog No./ Model	(S) Stroke mm	(E _T) Max. Nm/cycle	(E _T C) Max. Nm/h	(F _p) Max. Reaction N	Nominal Coil Spring Force		(F _D) Max. Propelling N	Model Weight Kg
					Extended N	Compressed N		
ECO 8 (B)	6,4	3,0	5 650	890	2,7	5,6	200	16
ECO 10 (B)	7,0	6,0	12 400	1 600	2,2	4,5	350	28
ECO 15 (B)	10,4	10,0	28 200	2 000	3,0	7,0	220	56
ECO S 25 (B)	12,7	20,0	34 000	2 800	4,5	11,0	890	68
ECO 25 (B)	16,0	26,0	34 000	2 800	4,5	11,0	890	68
ECO S 50 (B)	12,7	28,0	45 200	3 750	6,0	15,0	1 600	123
ECO 50 (B)	22,0	54,0	53 700	3 750	8,9	30,0	1 600	136
ECO 100 (B)	25,0	90,0	70 000	5 500	13,0	27,0	2 200	297

Catalog No./ Model	Damping Constant	A mm	A ₁ mm	C mm	D mm	E ₁ mm	F mm	G mm	H mm	J mm	WF mm	WL mm
ECO 8 IF (B)	-1,-2,-3			M8 x 0,75								
ECO 8 MF (B)	-1,-2,-3	47,0	57,0	M8 x 1,0	2,5	6,8	40,9	6,6	4,6	2,5	-	-
ECO 8 MC (B)	-1,-2,-3											
ECO 10 MF (B)	-1,-2,-3	54,0	64,0	M10 x 1,0	3,0	8,6	46,5	8,6	4,6	3,3	-	-
ECO 15 MF(B)	-1,-2,-3,-4	62,2	72,4	M12 x 1,0	3,0	10,2	52,1	9,9	6,9	2,5	11,0	9,5
ECO S 25 MF (B)	-1,-2,-3			M14 x 1,0								
ECO S 25 MC (B)	-1,-2,-3	82,7	92,2	M14 x 1,5	4,0	11,2	69,5	10,9	5,1	1,0	12,0	12,7
ECO 25 MF (B)	-1,-2,-3,-4			M14 x 1,0								
ECO 25 MC (B)	-1,-2,-3,-4	97,5	107,2	M14 x 1,5	4,0	11,2	81,3	10,9	7,6	1,0	12,0	12,7
ECO S 50 MC (B)	-1,-2,-3	87,9	99,9	M20 x 1,5	4,8	12,7	74,4	16,3	7,6	1,0	18,0	12,7
ECO 50 MC (B)	-1,-2,-3,-4	118,4	130,3	M20 x 1,5	4,8	12,7	95,5	16,3	7,6	1,0	18,0	12,7
ECO 100 MF (B)	-1,-2,-3,-4			M25 x 1,5								
ECO 100 MC (B)	-1,-2,-3,-4	128,8	141,5	M27 x 3,0	6,4	15,7	102,6	22,0	12,7	4,6	23,0	12,7

Notes: 1. See page 57 for constant damping curves.

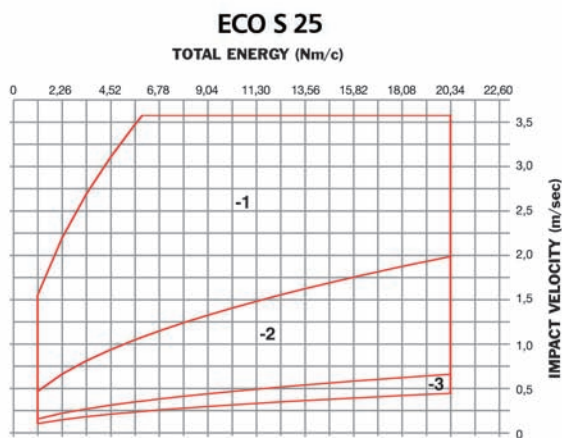
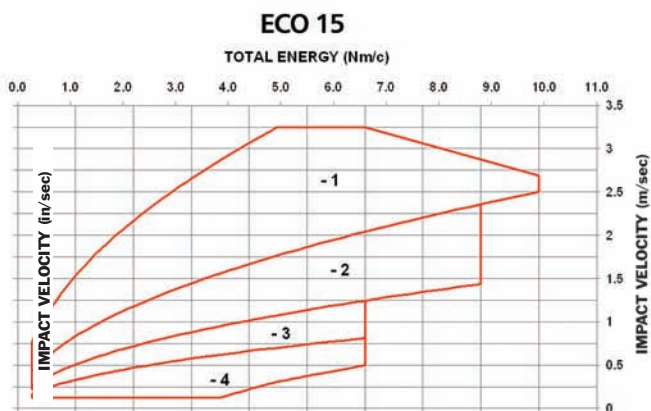
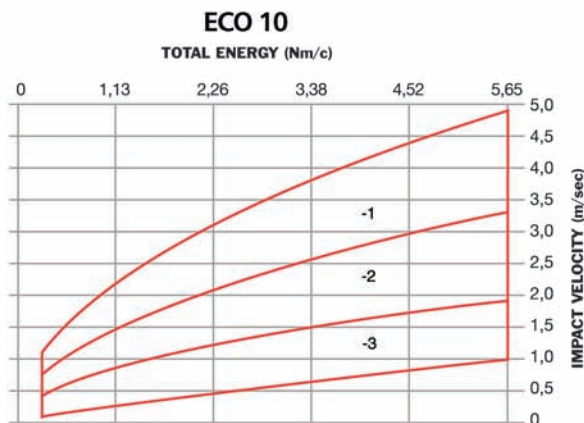
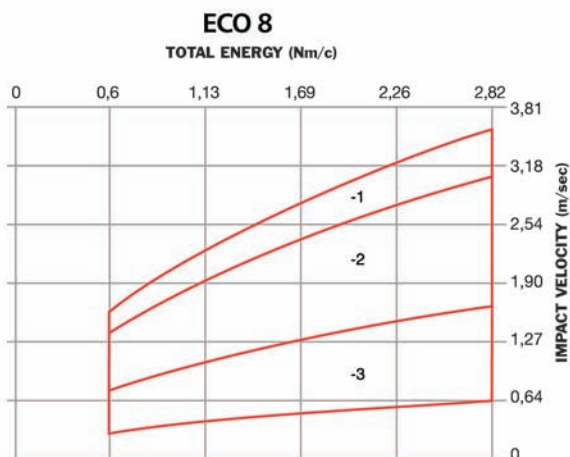

Note: Minimum impact velocity for ECO models is 0,1 m/sec

ECO 25 → ECO 100 Series

Sizing Curves

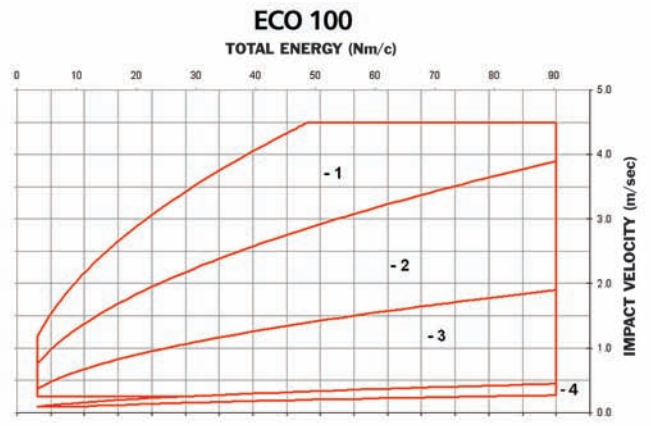
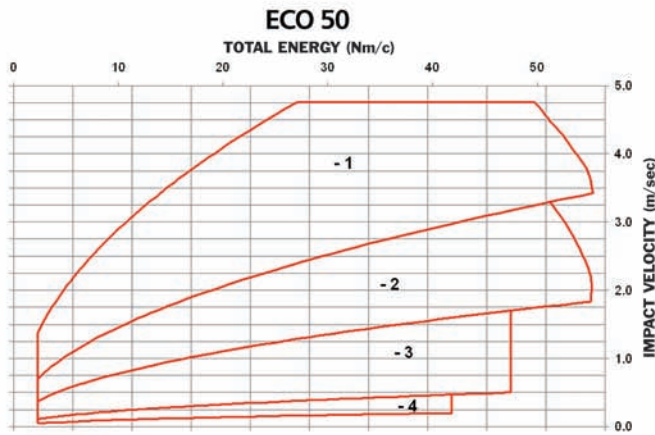
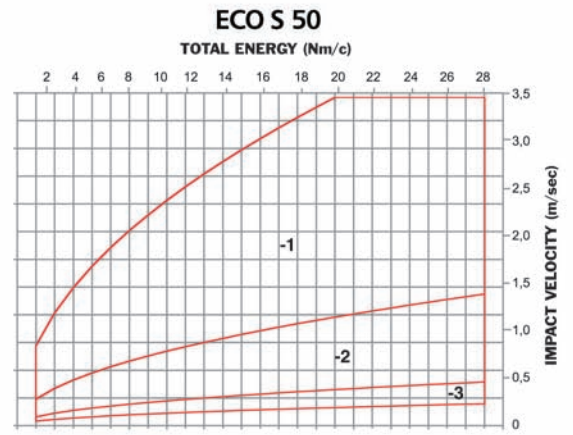
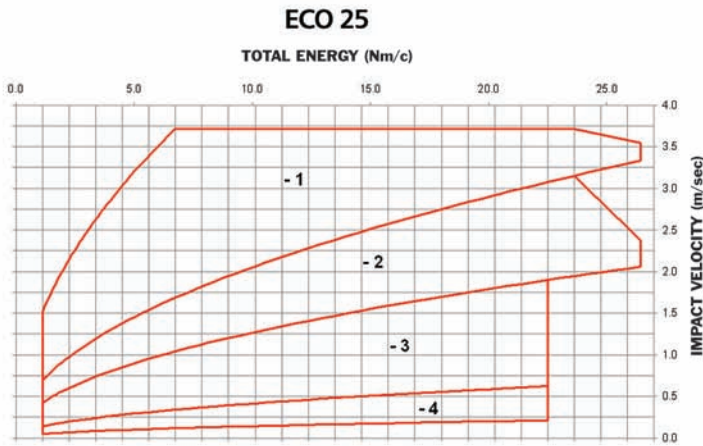

Note: Minimum impact velocity for ECO models is 0,1 m/sec

ECO 8 → ECO 100 Series

Jam Nut (JN)

*Note: One Hex Jam Nut included with every shock absorber.

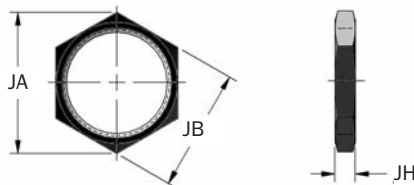

Catalog No./ Model	ECO Series Part Number	Model (Ref)	JA mm	JB mm	JH mm	Mass g
JN M8 x 0,75	J223839185	ECO 8 MF (B)	14,0	12,0	4,0	2
JN M8 x 1	J223839035	ECO 8 MC (B)	14,0	12,0	4,0	2
JN M10 x 1	J223840167	ECO 10 MF (B)	17,3	15,0	4,0	2
JN M12 x 1	J223841035	ECO 15 M (B)	15,0	13,0	3,2	2
JN M14 x 1	J223842035	ECO S/ECO 25 MF (B)	19,7	17,0	4,0	3
JN M14 x 1,5	J223842165	ECO S/ECO 25 MC (B)	19,7	17,0	4,0	3
JN M20 x 1,5	J223844035	ECO S/ECO 50 MC (B)	27,7	24,0	4,6	9
JN M25 x 1,5	J223846035	ECO 100 MF (B)	37,0	32,0	4,6	15

Stop Collar (SC)

ECO8 → ECO100

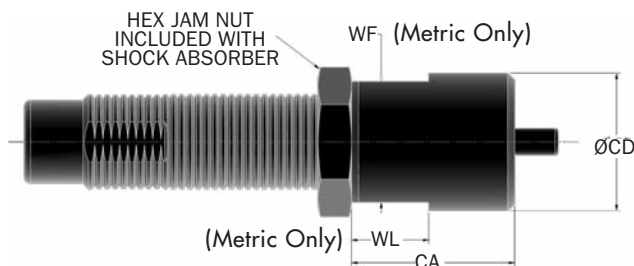

Catalog No./ Model	ECO Series Part Number	Model (Ref)	CA mm	CB mm	CD mm	WF mm	WL mm	Mass g
SC M8 x 0,75	M923839175	ECO 8 MF (B)	19,0	12,0	14,0	–	–	23
SC M8 x 1	M923839058	ECO 8 MC (B)	19,0	12,0	14,0	–	–	23
SC M10 x 1	M923840171	ECO 10 MF (B)	19,0	–	14,3	–	–	11
SC M12 x 1	M923841058	ECO 15 M (B)	19,0	–	16,0	14,0	9,0	14
SC M14 x 1,5	M923842171	ECO S/ECO 25 MF (B)	25,4	–	21,0	19,0	12,0	38
SC M14 x 1	M923842058	ECO S/ECO 25 MF (B)	25,4	–	18,0	17,0	12,0	20
SC M20 x 1,5	M924057058	ECO S/ECO 50 M (B)	38,0	–	25,0	22,0	12,0	63
SC M25 x 1,5	M923846171	ECO 100 MF (B)	44,5	–	38,0	32,0	15,0	215

ECO 8 → ECO 100 Series

Accessories

Side Load Adaptor (SLA)

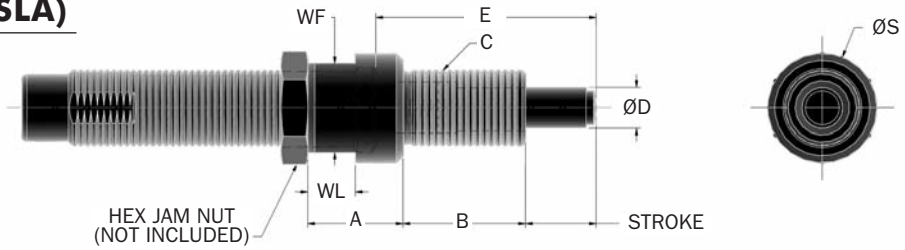

Catalog No./ Model	ECO Series Part Number	Model (Ref)	Stroke mm	A mm	B mm	C mm	D mm	E mm	S mm	WF mm	WL mm
SLA 10 MF	SLA 33457	ECO 10 MF	6,4	12	11	M10 x 1	5,0	21,9	13,0	11,0	4,0
SLA 12 MF	SLA 33299	ECO 15 MF	10,0	18	14	M12 x 1	6,0	32,4	14,0	13,0	7,0
SLA 14 MF	SLA 33297	ECO 25 MF	16,0	26	13	M14 x 1	8,0	45,2	18,0	15,0	7,0
SLA 14 MC	SLA 33298	ECO 25 MC	12,7	20	16	M14 x 1,5	8,0	39,2	18,0	15,0	7,0
SLA 14 MFS	SLA 33306	ECO S 25 MF	12,7	20	16	M14 x 1	8,0	39,2	18,0	15,0	7,0
SLA 14 MCS	SLA 33301	ECO S 25 MC	12,7	20	16	M14 x 1,5	8,0	39,2	18,0	15,0	7,0
SLA 20 MC	SLA 33302	ECO 50 M	22,0	32	17	M20 x 1,5	11,0	62,0	25,0	22,0	7,0
SLA 20 MCS	SLA 33262	ECO S 50 M	12,7	24	14	M20 x 1,5	11,0	41,5	25,0	22,0	7,0
SLA 25 MF	SLA 33263	ECO 100 MF	25,4	38	30	M25 x 1,5	15,0	73,2	36,0	32,0	7,0
SLA 25 MC	SLA 33296	ECO 100 MC	25,4	38	30	M27 x 3	15,0	73,2	36,0	32,0	10,0

Notes: 1. Maximum sideload angle is 30°. 2. Part numbers in page color are non-standard lead time items, contact Enidine.

Universal Retaining Flange (UF)

UF M10 x 1 → UF M14 x 1,5

UF M20 x 1,5 → UF M27 x 3

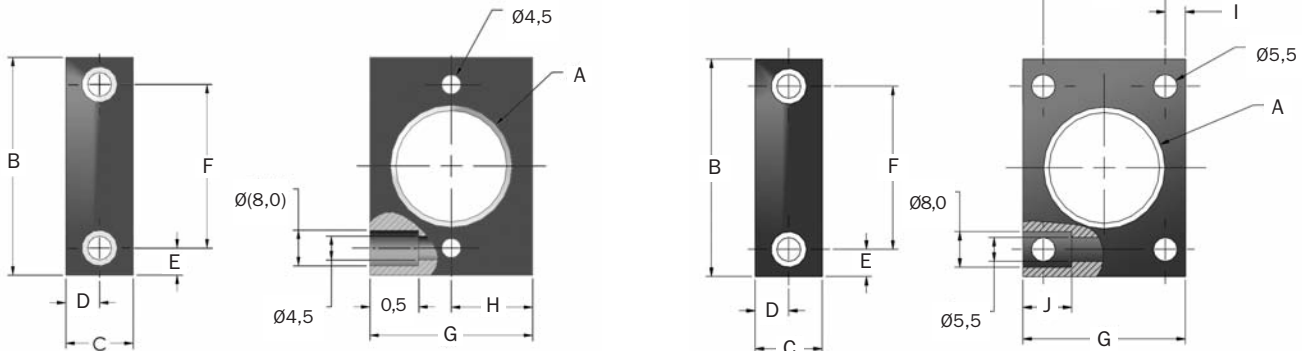

Catalog No./ Model	ECO Series Part Number	Model (Ref)	A mm	B mm	C mm	D mm	E mm	F mm	G mm	H mm	I mm	J mm	K mm
UF M10 x 1	U16363189	ECO 10M	M10 x 1	38,0	12,0	6,0	6,25	25,5	25,0	12,5	—	5,0	—
UF M12 x 1	U15588189	ECO 15 M (B)	M12 x 1	38,0	12,0	6,0	6,25	25,5	25,0	12,5	—	5,0	—
UF M14 x 1	U14950189	ECO/ECO S 25 MF (B)	M14 x 1,5	45,0	16,0	8,0	5,0	35,0	30,0	15,0	—	5,0	—
UF M14 x 1,5	U13935143	ECO/ECO S 25 MC (B)	M14 x 1,5	45,0	16,0	8,0	5,0	35,0	30,0	15,0	—	5,0	—
UF M20 x 1,5	U12646143	ECO/ECO S 50 MC (B)	M20 x 1,5	48,0	16,0	8,0	6,5	35,0	35,0	—	4,75	10,0	25,5
UF M25 x 1,5	U13004143	ECO 100/110M	M25 x 1,5	48,0	16,0	8,0	6,5	35,0	35,0	—	4,75	10,0	25,5
UF M27 x 3	U12587143	ECO 100 MC	M27 X 3	48,0	16,0	8,0	6,5	35,0	35,0	—	4,75	10,0	25,5

Notes: 1. Part numbers in page color are non-standard lead time items, contact Enidine.

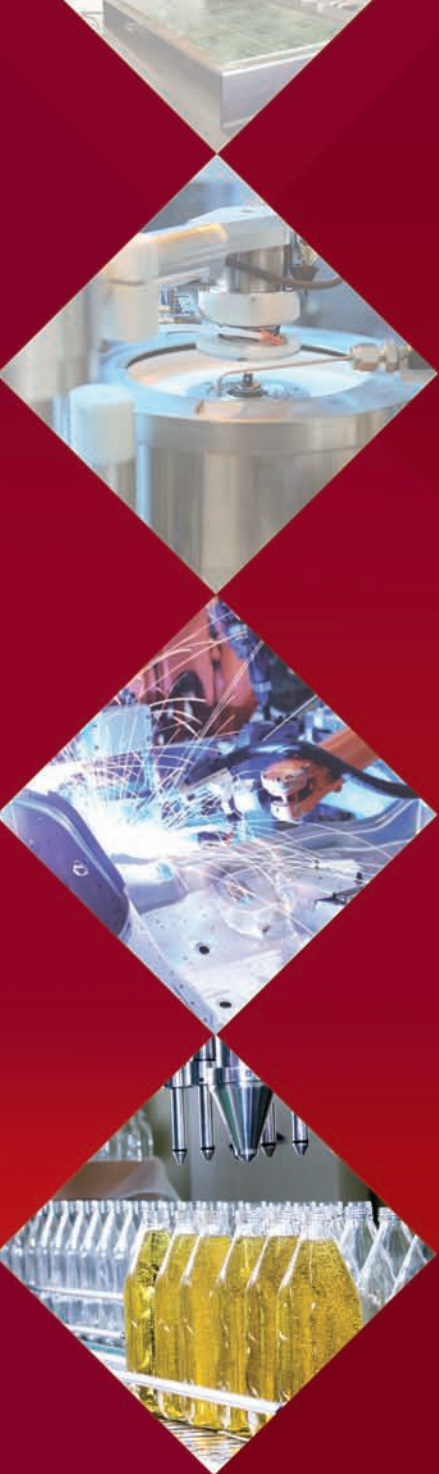

ITT

ENGINEERED FOR LIFE

ITT Control Technologies EMEA
Werkstrasse 5
D-64732, Bad Koenig
Germany
Phone: +49 6063 9314 0
Fax: +49 6063 9314 44
www.enidine.eu